

## **TRAINING LAB – FIREARMS AND BALLISTICS: BARREL AND BULLET STRIATIONS**

NAME \_\_\_\_\_

**Background:** You have learned that the inside of a firearm’s barrel contains lands and grooves in a twisting pattern, which forces an exiting bullet to spin. The pattern of lands and grooves can help you determine the manufacturer of a firearm – an example of Class Evidence. You may also recall that many small scratches or **STRIATIONS** are left behind in a firearm’s barrel during the process of manufacturing the lands and grooves – and that each firearm has its own unique set of striation “fingerprints”. This is an example of Individual Evidence. In this Training Lab you will continue your study of **BALLISTICS** (the study of firearms and the bullets they fire) and investigate barrel and bullet striations in more detail.

1. You will be trained to analyze the striation patterns on evidence bullets and use this information to help solve a crime.

### **Procedures:**

1. The striations in a firearm’s barrel are just like fingerprints – each with its own unique pattern of striations. When a bullet is fired it rubs against the inside of the firearm’s barrel and picks up an imprint of the barrel’s unique striations. Find a bullet at a crime scene and you can use the bullet’s striation marks to identify the gun that fired it.
2. You need two things to identify a gun that fired a bullet at a crime scene:
  - A. You need an evidence bullet that has visible striation marks. This can be a problem because many times the bullet is destroyed when it hits an object – fragmenting into many pieces or being smashed in a way that destroys the striations. However, you can still match an evidence bullet to a gun if only a portion of the evidence bullet contains striation marks.
  - B. You need the firearm that you think may have fired the bullet. It is difficult to actually check the striations inside a gun’s barrel to compare them to an evidence bullet’s striations. It’s much easier to fire another bullet from the suspect gun and compare the striations on this known bullet to the striations on the evidence bullet to see if they match. The known bullet is usually shot into a large tank of water where it can be collected without any damage.
3. Now, let’s put your ballistic skills to work and solve the following crime!

### THE MYSTERY OF THE SEXTUPLET MURDER

You arrive at 4680 Barberry Drive and discover a murder. Bobby Barrister, 32 years old, was shot ONCE in the chest while sitting on the couch in his living room. You also observe FOUR other bullet holes in the living room, however, none of these shots hit Bobby (see Figure 1 for a sketch of the crime scene). Bullet Evidence #1 and #2 were found in the wall behind the couch, Bullet Evidence #3 and #5 were found in the couch, and Bullet Evidence #4 passed through Bobby’s body and entered the couch. You carefully remove all FIVE bullets for analysis.

Several of the neighbors say they know exactly who murdered Bobby Barrister – one of his brothers. It seems Bobby Barrister was a Sextuplet, one of six brothers born at the same time. Neighbors observed all five of Bobby’s brothers (Barry, Bradley, Brian, Brandon, and Billy-Bob) arrive at the house, heard gunshots a few minutes later, then watched as the five brothers ran to their car and sped away. The five brothers were later discovered at Billy-Bob’s house, arrested, and taken into custody. Each brother had a handgun in his possession at the time of arrest, and each of the five handguns was the same make, model, and manufacturer - identical brothers with identical guns.

The problem is that investigators don’t know which brother to charge with murder (which brother fired the fatal shot – Bullet Evidence #4), and which brothers fired the other four shots in the living room. The brothers are not cooperating and will not talk. It seems the key to this case may be the bullet evidence you collected from the crime scene. However, you must collect one more set of bullets before you can determine who murdered Bobby. You place a bullet in Barry’s handgun, fire it into a tank of water in your lab, then collect and label the bullet. You then complete the same procedure, firing and collecting a bullet from each of the remaining brother’s handguns. Can you accurately determine which brothers fired which bullets and solve this crime? Time to analyze the bullets.

- Pick up scissors, tape, a stereomicroscope, and the “Bullet Evidence” and “Bullet Fired From Gun” forms from your supervisor. Each strip you see on the “Bullet Evidence” and “Bullet Fired From Gun” forms represents the enlarged base of a bullet (the tip of each bullet is not shown) scarred with the markings of a barrel’s lands and striations.
- Cut out each strip along the large, solid black, rectangular line.

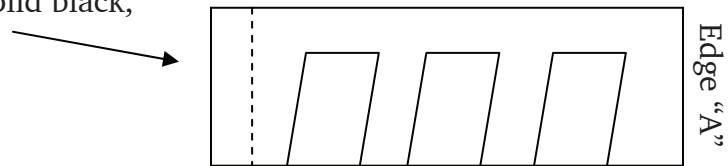

- Roll the cut-out strips into cylinders (land and striation marks facing out) so that Edge “A” is lined up along the dotted line of the opposite edge. Tape Edge “A” to the dotted line (this will hold the strip in a cylinder shape).

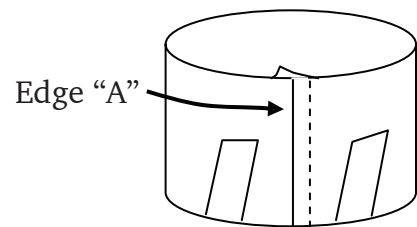

- The cylinders labeled “Bullet Evidence” represent the FIVE bullets you recovered from the crime scene (greatly enlarged). As expected, these bullets are not in perfect shape and have been damaged during impact.
- The FIVE cylinders labeled “Bullet Fired From Gun” represent the bullets you fired from each of the brother’s handguns (greatly enlarged).

9. Remember, the striation marks inside every barrel are unique - just like a fingerprint. Your job will be to carefully compare and match up striation marks to determine which bullets were fired from which guns. In fact, you don't even know if all the brothers fired their handguns. Maybe all the bullets came from the same gun??

A. You can use your eyes to try and make matches, however, you MUST confirm all matches with a stereomicroscope. Magnifying the striations will help you avoid mistakes! Striation markings on bullets should match PERFECTLY if they were fired from the same gun.

B. The "Bullet Evidence" cylinders have been made slightly smaller than the "Bullet Fired From Gun" cylinders. This will allow you to place the "Bullet Evidence" cylinders INSIDE the "Bullet Fired From Gun" cylinders so you can observe striation markings from the two bullets side by side. In a real lab this is accomplished with a special stereomicroscope that lets you look at two bullets at once, side by side.

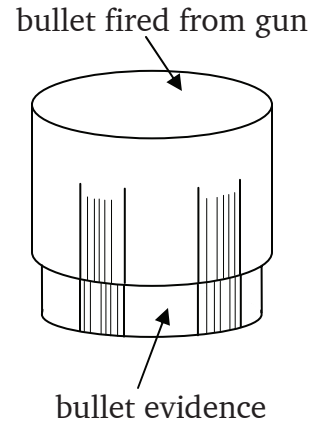

10. After you have completed your analysis and confirmed your results with the stereomicroscope you can record your conclusions in Table 1.

Table 1 – Which brother(s) fired bullets at the crime scene? A checkmark indicates a match was found between an Evidence Bullet and the bullet test fired from a brother's handgun.











		Bullet Fired From Barry's Gun 	Bullet Fired From Bradley's Gun 	Bullet Fired From Brian's Gun 	Bullet Fired From Brandon's Gun 	Bullet Fired From Billy-Bob's Gun 
Bullet Evidence #1 						
Bullet Evidence #2 						
Bullet Evidence #3 						
Bullet Evidence #4 						
Bullet Evidence #5 						

Figure 1 - Bobby Barrister's Living Room







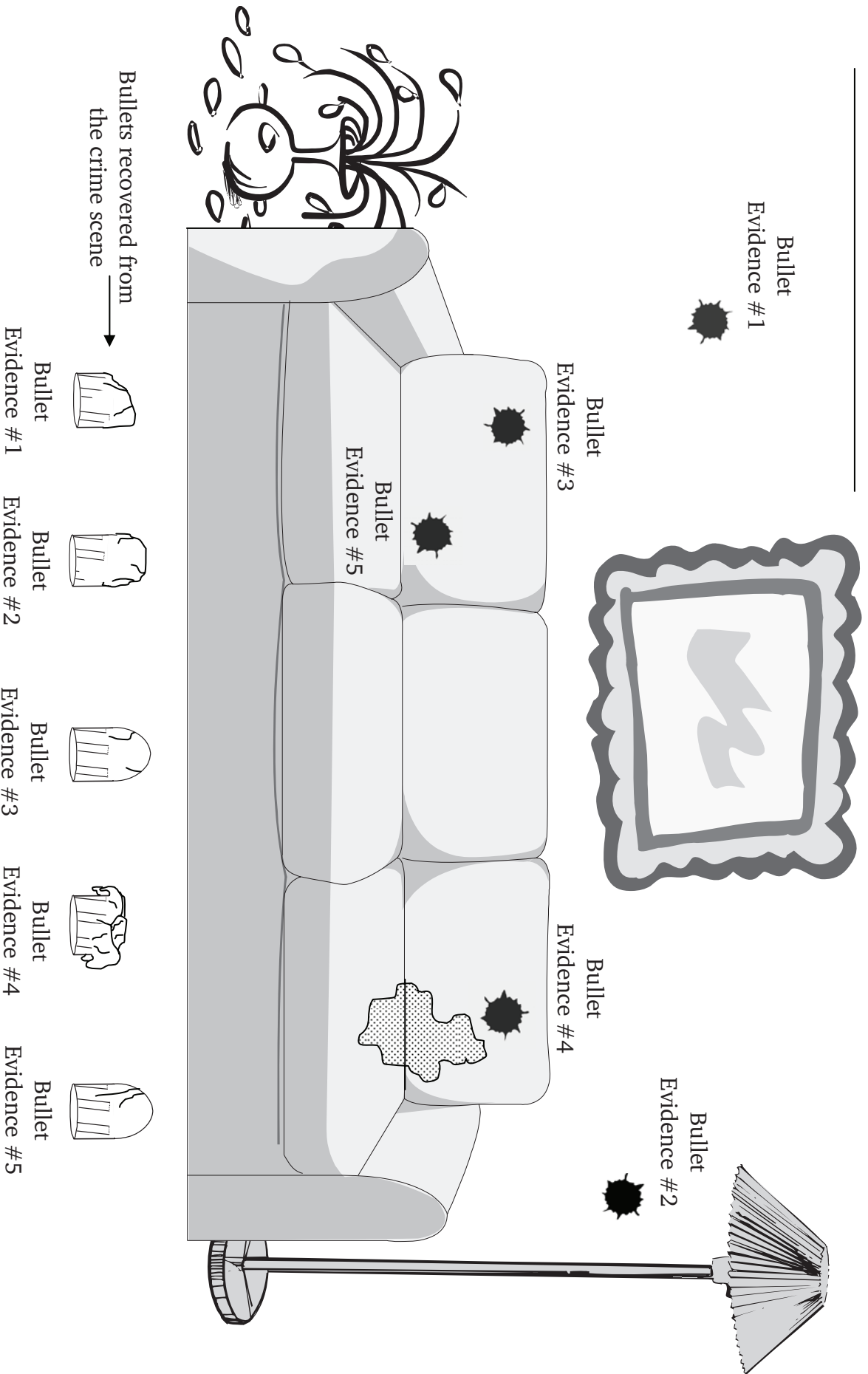
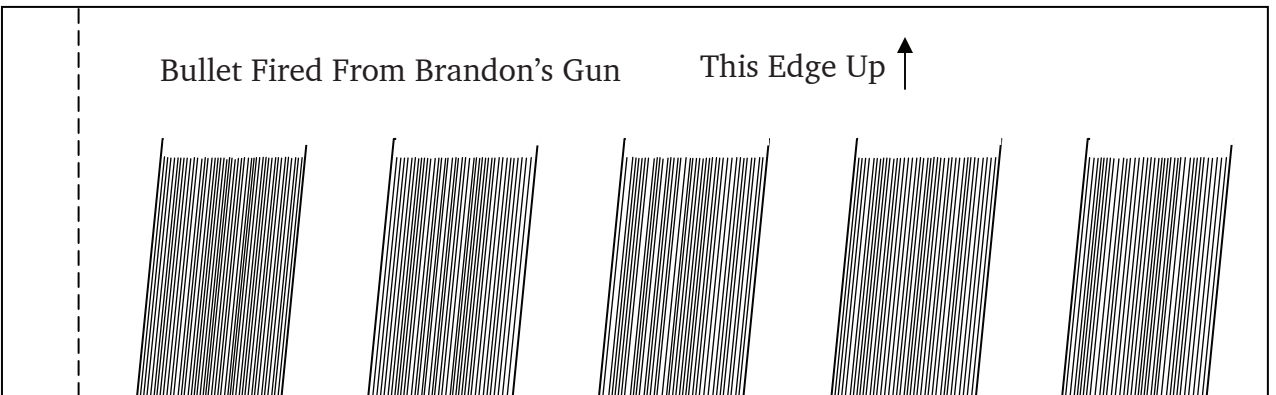
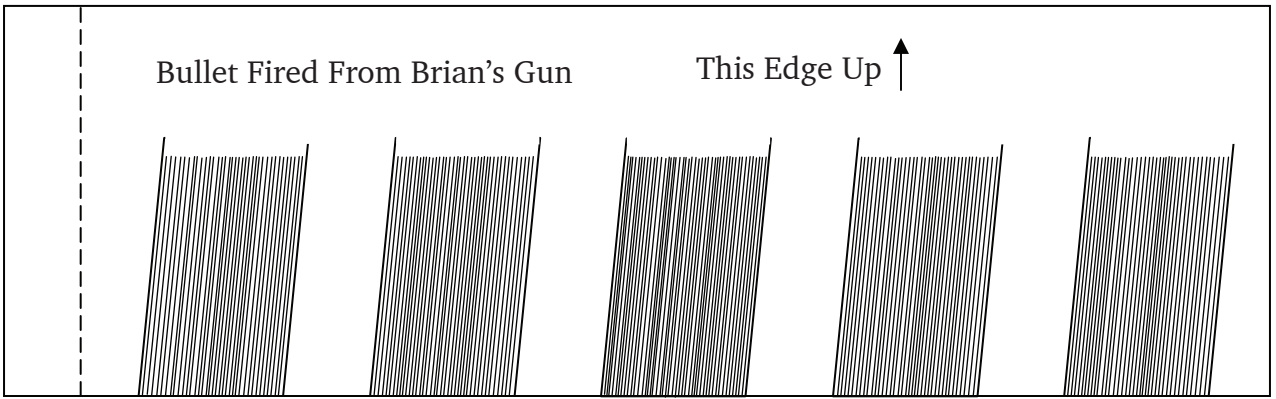
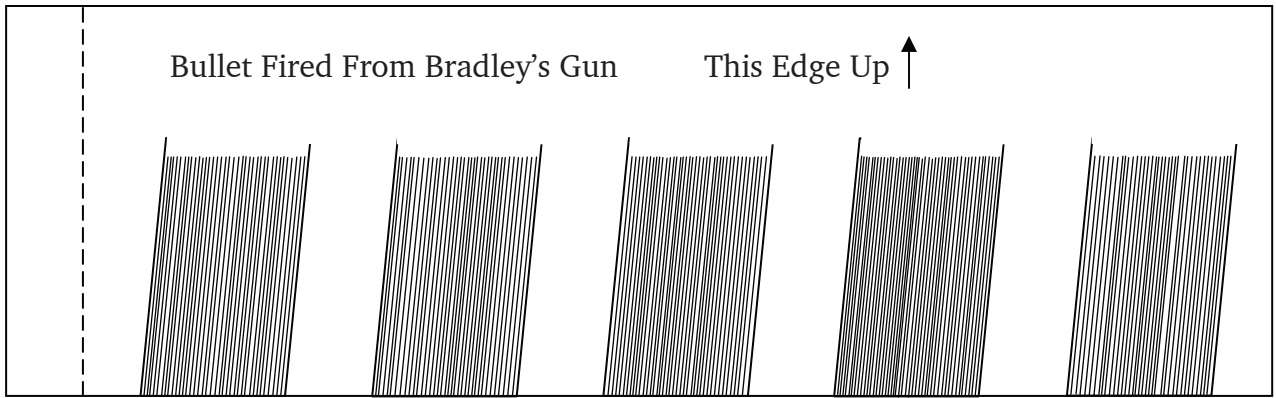
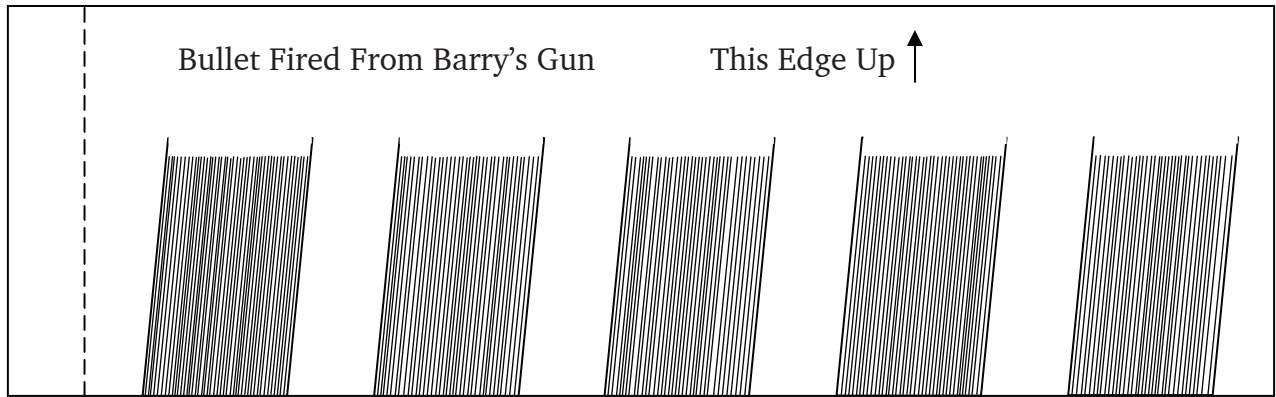
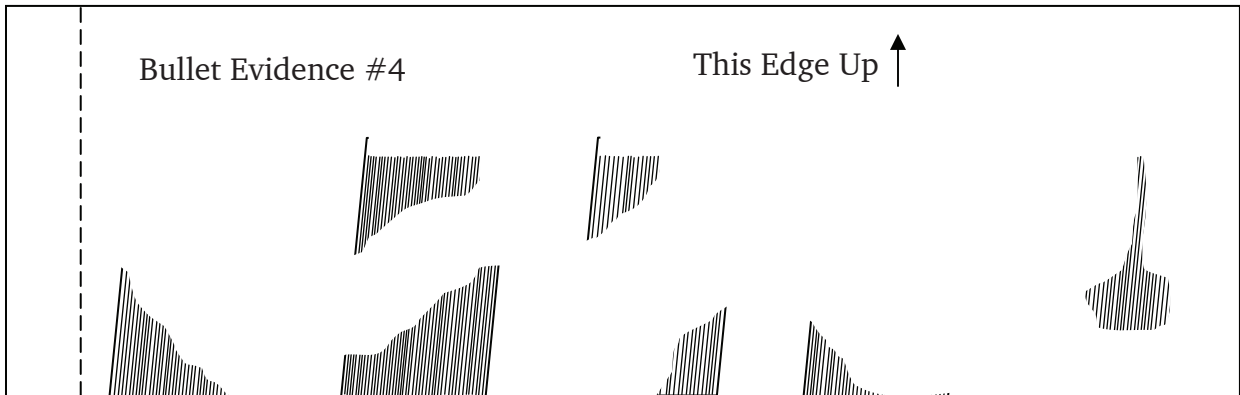
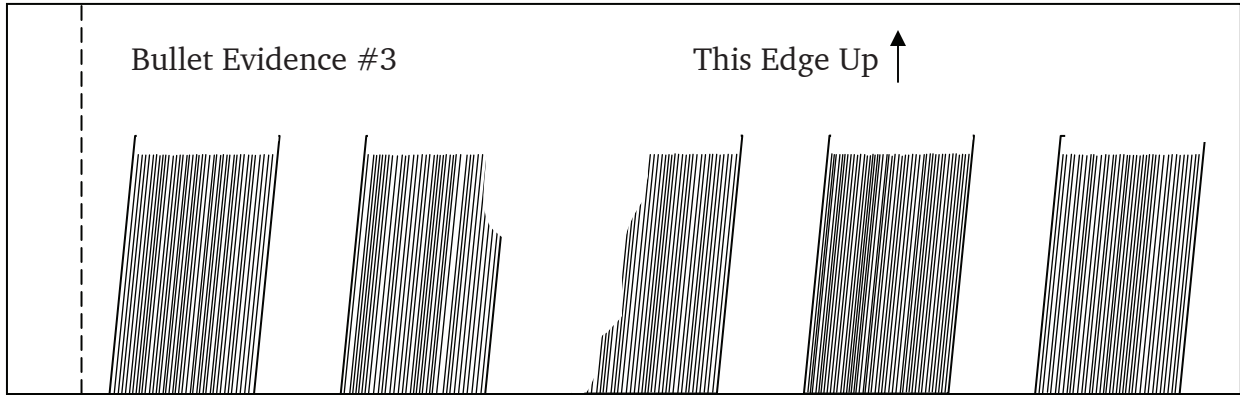
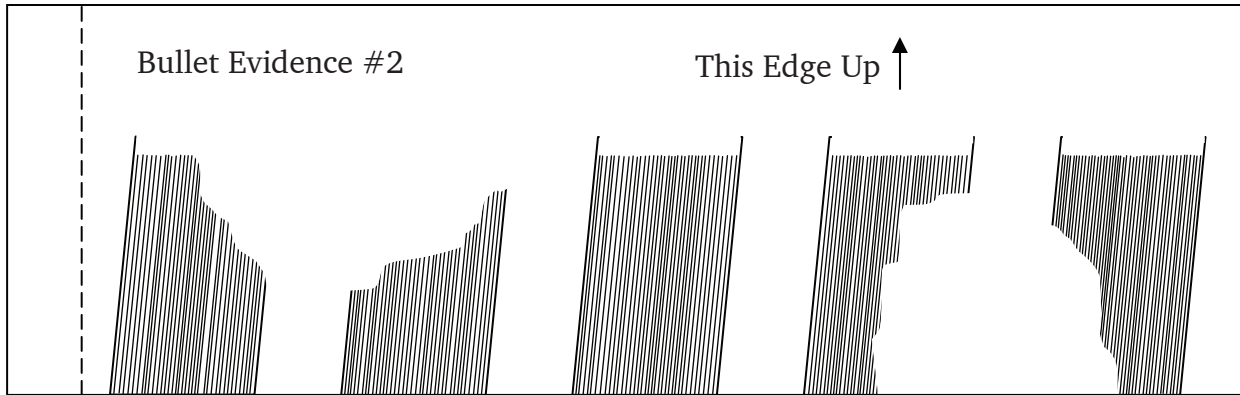
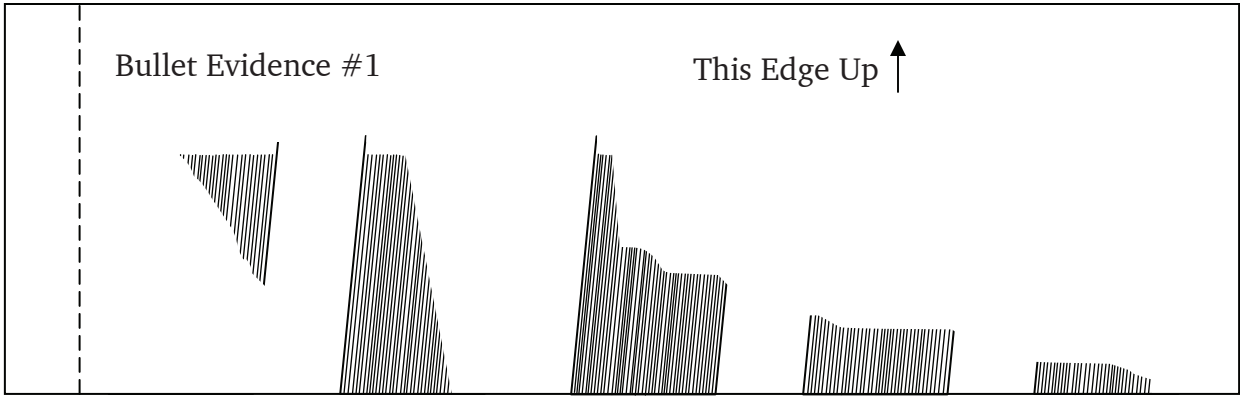
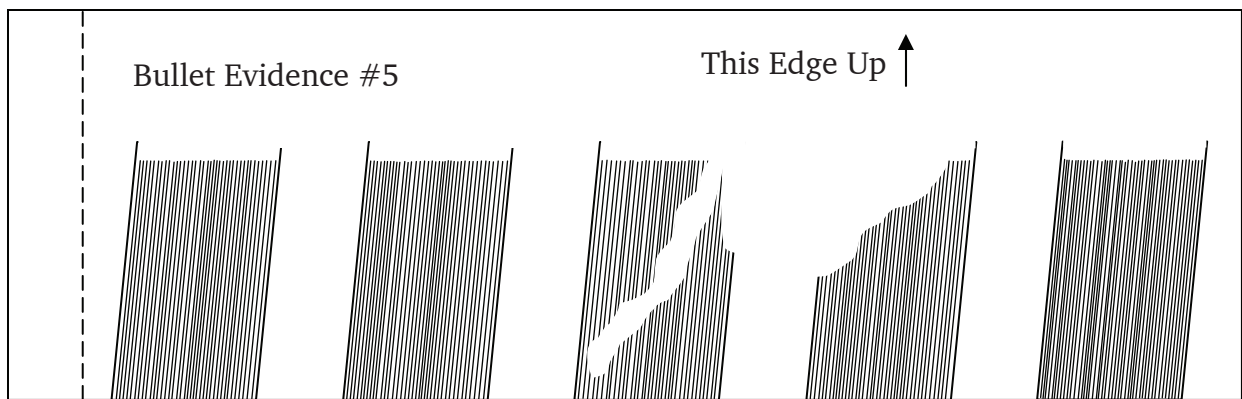
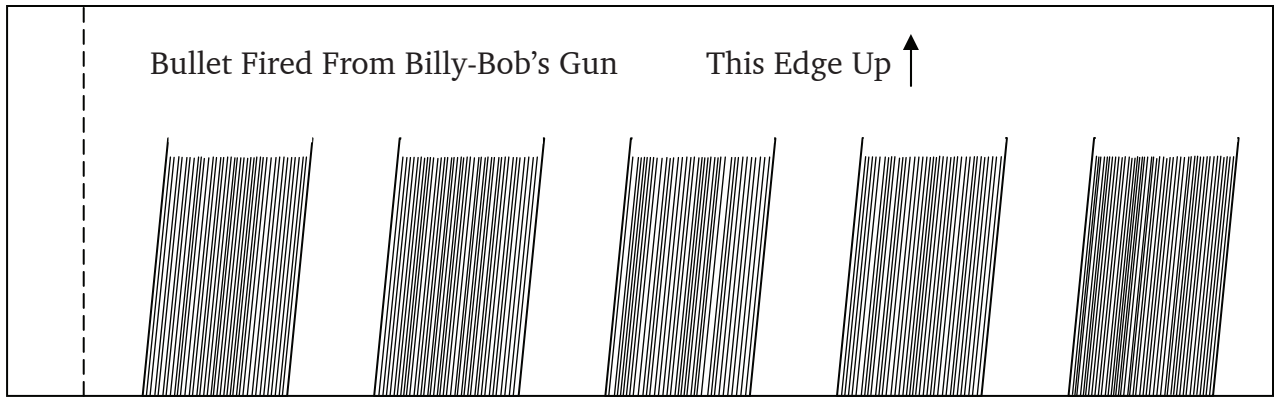

**QUESTIONS – FIREARMS AND BALLISTICS: BARREL AND BULLET STRIATIONS**

NAME \_\_\_\_\_

1. Complete the following information to summarize your analysis of the “Mystery of the Sextuplet Murder”.

Brother Barry’s gun fired Bullet Evidence #(s) \_\_\_\_\_

Brother Bradley’s gun fired Bullet Evidence #(s) \_\_\_\_\_

Brother Brian’s gun fired Bullet Evidence #(s) \_\_\_\_\_

Brother Brandon’s gun fired Bullet Evidence #(s) \_\_\_\_\_

Brother Billy-Bob’s gun fired Bullet Evidence #(s) \_\_\_\_\_

2. Which brother is likely responsible for the murder of Bobby Barrister? \_\_\_\_\_

3. Which brother(s) shot the living room wall? \_\_\_\_\_

4. All the brothers used the same make and model of handgun. Who manufactured the brother’s handguns?

How did you know? \_\_\_\_\_

5. Your ability to solve this crime proves you are on your way to becoming a ballistics expert. Explain, in your own words, what a ballistic expert does.

6. List FOUR things you, a ballistics expert, would observe on a bullet that was found at a crime scene – then describe what each thing on your list could help you discover.

I would observe:

To help me discover:

\_\_\_\_\_

\_\_\_\_\_

\_\_\_\_\_

\_\_\_\_\_

\_\_\_\_\_

\_\_\_\_\_

\_\_\_\_\_

\_\_\_\_\_